



LITHIUM IRON PHOSPHATE BATTERY

ELECTRICAL SPECIFICATIONS

Nominal Voltage	25.6 V
Nominal Capacity	100 Ah
Capacity @ 25A	240 min
Energy	2560 Wh
Resistance	≤30 mΩ @ 50% SOC
Efficiency	99%
Self Discharge	<3% per Month
Maximum Modules in Series	1 (Single Use)

DISCHARGE SPECIFICATIONS

Maximum Continuous Discharge Current	100 A
Peak Discharge Current	200 A (7.5 s ±2.5 s)
BMS Discharge Current Cut-Off	280 A ±50 A (9 ±4 ms)
Recommended Low Voltage Disconnect	22 V
BMS Discharge Voltage Cut-Off	16 V (2.0 ±0.08 vpc) (20 ±6 ms)
Reconnect Voltage	20 V (2.5 ±0.05 vpc)
Short Circuit Protection	200-600 μs

TEMPERATURE SPECIFICATIONS

Discharge Temperature	-4 to 140 °F (-20 to 60 °C)
Charge Temperature	-4 to 113 °F (-20 to 45 °C)
Storage Temperature	23 to 95 °F (-5 to 35 °C)
BMS High Temperature Cut-Off	176 °F (80 °C)
Reconnect Temperature	122 °F (50 °C)

*Refer to charge currents below 32°F (0°C)

DIMENSIONAL SPECIFICATIONS

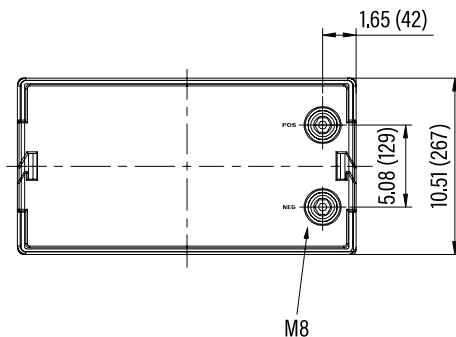

MECHANICAL SPECIFICATIONS

Dimensions (L x W x H)	20.5 x 10.5 x 9.0"
	520 x 267 x 228 mm
Weight	61.1 lbs (27.7 kg)
Terminal Type	M8
Terminal Torque	80 - 100 in-lbs (9 - 11 N-m)
Case Material	ABS
Enclosure Protection	IP56
Cell Type - Chemistry	Cylindrical - LiFePO ₄

CHARGE SPECIFICATIONS

Recommended Charge Current	5 A - 50 A
Maximum Charge Current	100 A
Charge Current 14 to 32 °F (-10 to 0 °C)	≤0.1 C
Charge Current -4 to 14 °F (-20 to -10 °C)	≤0.05 C
Recommended Charge Voltage	28.4 V - 29.2 V
BMS Charge Voltage Cut-Off	31.2 V (3.9 ±0.025 vpc) (1.1 ±0.4 s)
Reconnect Voltage	28.8 V (3.8 ±0.05 vpc)
Balancing Voltage	28.8 V (3.6 vpc)

COMPLIANCE SPECIFICATIONS

Certifications	CE (battery) UL1642 & IEC62133 (cells)
Shipping Classification	UN 3480, CLASS 9

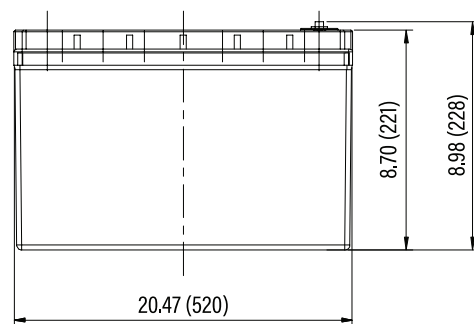



RB24V100

Group: 8D

PERFORMANCE CHARACTERISTICS

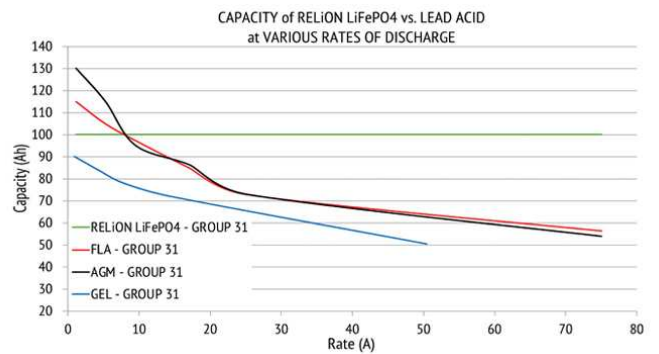
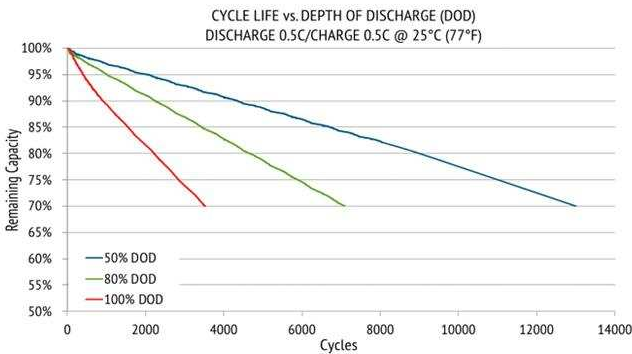
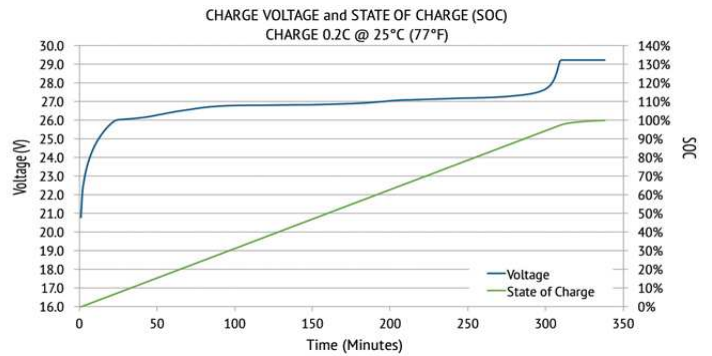
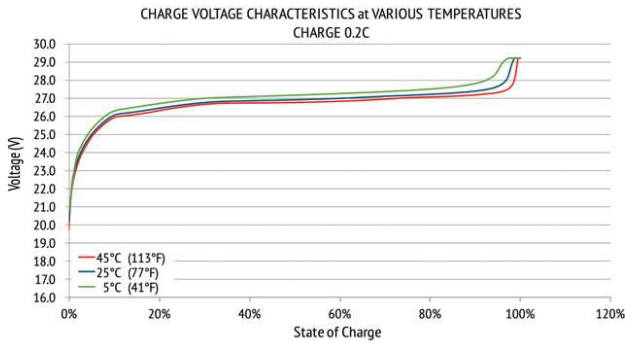
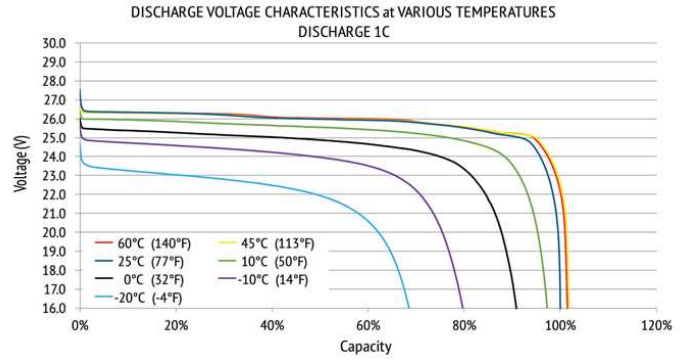
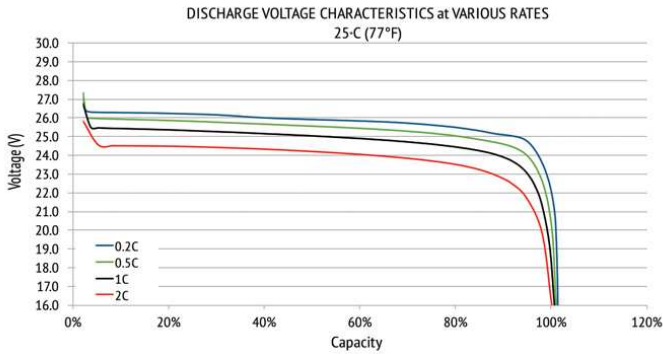

RB24V100DS04.20.2020

