

12,8 & 25,6 Volt Lithium-Iron-Phosphate Batteries Smart With Bluetooth

www.victronenergy.com

Why lithium-iron-phosphate?

Lithium-iron-phosphate (LiFePO₄ or LFP) is the safest of the mainstream li-ion battery types. The nominal voltage of a LFP cell is 3,2V (lead-acid: 2V/cell). A 12,8V LFP battery therefore consists of 4 cells connected in series; and a 25,6V battery consists of 8 cells connected in series.

Rugged

A lead-acid battery will fail prematurely due to sulfation:

- If it operates in deficit mode during long periods of time (i.e. if the battery is rarely, or never at all, fully charged).
- If it is left partially charged or worse, fully discharged (yacht or mobile home during wintertime).

A LFP battery does not need to be fully charged. Service life even slightly improves in case of partial charge instead of a full charge. This is a major advantage of LFP compared to lead-acid.

Other advantages are the wide operating temperature range, excellent cycling performance, low internal resistance and high efficiency (see below).

LFP is therefore the chemistry of choice for demanding applications.

Efficient

In several applications (especially off-grid solar and/or wind), energy efficiency can be of crucial importance. The round-trip energy efficiency (discharge from 100% to 0% and back to 100% charged) of the average lead-acid battery is 80%.

The round-trip energy efficiency of a LFP battery is 92%.

The charge process of lead-acid batteries becomes particularly inefficient when the 80% state of charge has been reached, resulting in efficiencies of 50% or even less in solar systems where several days of reserve energy is required (battery operating in 70% to 100% charged state).

In contrast, a LFP battery will still achieve 90% efficiency under shallow discharge conditions.

Size and weight

Saves up to 70% in space

Saves up to 70% in weight

Expensive?

LFP batteries are expensive when compared to lead-acid. But in demanding applications, the high initial cost will be more than compensated by longer service life, superior reliability and excellent efficiency.

Bluetooth

With Bluetooth cell voltages, temperature and alarm status can be monitored.

Very useful to localize a (potential) problem, such as cell imbalance.



12,8V 300Ah LiFePO₄ Battery

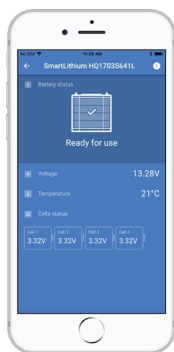

Li-ion app

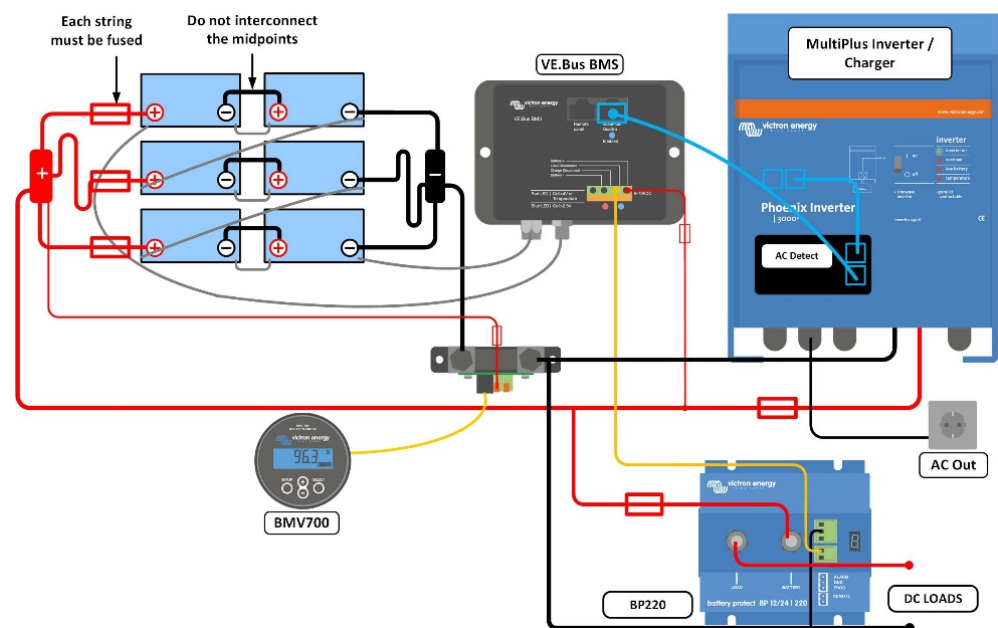

Our LFP batteries have integrated cell balancing and cell monitoring. Up to 5 batteries can be paralleled and up to four 12V batteries or two 24V batteries can be series connected, so that a 48V battery bank of up to 1500Ah can be assembled. The cell balancing/monitoring cables can be daisy-chained and must be connected to a Battery Management System (BMS).

Battery Management System (BMS)

The BMS will:

1. Generate a pre-alarm whenever the voltage of a battery cell decreases to less than 3,1V (adjustable 2,85 - 3,15 V).
2. Disconnect or shut down the load whenever the voltage of a battery cell decreases to less than 2,8V (adjustable 2,6 V - 2,8 V).
3. Stop the charging process whenever the voltage of a battery cell increases to more than 3,75 V or the temperature increases to more than 60°C.

See the BMS datasheets for more features

Battery specification										
VOLTAGE AND CAPACITY	LFP-Smart 12,8/50	LFP-Smart 12,8/60	LFP-Smart 12,8/100	LFP-Smart 12,8/160	LFP-Smart 12,8/200	LFP-Smart 12,8/300	LFP-Smart 12,8/330	LFP-Smart 25,6/100	LFP-Smart 25,6/200	LFP-Smart 25,6/200-a
Nominal voltage	12,8V	12,8V	12,8V	12,8V	12,8V	12,8V	12,8V	25,6V	25,6V	25,6V
Nominal capacity @ 25°C*	50Ah	60Ah	100Ah	160Ah	200Ah	300Ah	330Ah	100Ah	200Ah	200Ah
Nominal capacity @ 0°C*	40Ah	48Ah	80Ah	130Ah	160Ah	240Ah	260Ah	80Ah	160Ah	160Ah
Nominal capacity @ -20°C*	25Ah	30Ah	50Ah	80Ah	100Ah	150Ah	160Ah	50Ah	100Ah	100Ah
Nominal energy @ 25°C*	640Wh	768Wh	1280Wh	2048Wh	2560Wh	3840Wh	4220Wh	2560Wh	5120Wh	5120Wh
*Discharge current ≤1C										
CYCLE LIFE (capacity ≥ 80% of nominal)										
80% DoD	2500 cycles									
70% DoD	3000 cycles									
50% DoD	5000 cycles									
DISCHARGE										
Maximum continuous discharge current	100A	120A	200A	320A	400A	600A	400A	200A	400A	400A
Recommended continuous discharge current	≤50A	≤60A	≤100A	≤160A	≤200A	≤300A	≤300A	≤100A	≤200A	≤200A
End of discharge voltage	11,2V	11,2V	11,2V	11,2V	11,2V	11,2V	11,2V	22,4V	22,4V	22,4V
Internal resistance	2mΩ	2mΩ	0,8mΩ	0,9mΩ	0,8mΩ	0,8mΩ	0,8mΩ	1,6mΩ	1,5mΩ	1,5mΩ
OPERATING CONDITIONS										
Operating temperature	Discharge: -20°C to +50°C Charge: +5°C to +50°C									
Storage temperature	-45°C to +70°C									
Humidity (non-condensing)	Max. 95%									
Protection class	IP 22									
CHARGE										
Charge voltage	Between 14V/28V and 14,4V/28,8V (14,2V/28,4V recommended)									
Float voltage	13,5V/27V									
Maximum charge current	100A	120A	200A	320A	400A	600A	400A	200A	400A	400A
Recommended charge current	≤30A	≤30A	≤50A	≤80A	≤100A	≤150A	≤150A	≤50A	≤100A	≤100A
OTHER										
Max storage time @ 25°C*	1 year									
BMS connection	Male + female cable with M8 circular connector, length 50cm									
Power connection (threaded inserts)	M8	M8	M8	M8	M8	M10	M10	M8	M8	M8
Dimensions (hxxwxd) mm	199 x 188 x 147	239 x 286 x 132	197 x 321 x 152	237 x 321 x 152	237 x 321 x 152	347 x 425 x 274	265 x 359 x 206	197 x 650 x 163	317 x 631 x 208	237 x 650 x 163
Weight	7kg	12kg	14kg	18kg	20kg	51kg	30kg	28kg	56kg	39kg
*When fully charged										